

MONTAJE / MONTAGE / MONTAGGIO / MONTAGEM / ASSEMBLY / BEDIENUNGSANLEITUNG

ES TE ACONSEJAMOS

- Poner el paquete en posición horizontal.
- Ordenar y contar las piezas y herrajes.
- Habilita una zona para el montaje.
- Sigue paso a paso las instrucciones de montaje.

EN I ADVISE YOU

- Put the package in horizontal position.
- Put in the order and count the pieces and iron fittings.
- Take enough space for assembly.
- Follow step by step the assembly instruction.

FR NOUS VOUS CONSEILLONS

- Poser les colis en position horizontale.
- Classer et compter les éléments de montage et la quincaillerie.
- Définir une zone de montage.
- Suivre dans l'ordre les instructions de montage.

IT VI INFORMIAMO

- Porre la confezione in orizzontale.
- Mettere in ordine e contare le minuterie metaliche.
- Essere certi di avere spazio a per il montaggio.
- Seguire passo passo le istruzioni.

ES - Las herramientas que necesitas (no incluidas en el kit)

FR - Outils de montage nécessaires (not inclus dans le kit)

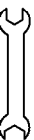
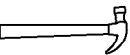

EN - The tools that you need for assembly (not included in the package)

IT - Gli attrezzi che vi servono per il montaggio (non inclusi nella confezione)

ES - Los herrajes que encontrarás en el kit

FR - Quincaillerie incluse dans le kit

EN - The tools that you will find in the package

IT - Accessori inclusi nella confezione.

X4 3 x 15 mm

X20 5 x 60 mm

X2 6 x 30 mm

X2 4,5 x 50 mm

ES - Las piezas incluidas en el kit

FR - Pièces incluses dans le kit

EN - The pieces included in the package

IT - Parti incluse nella confezione

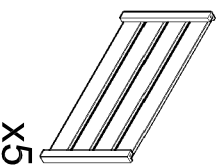

X5

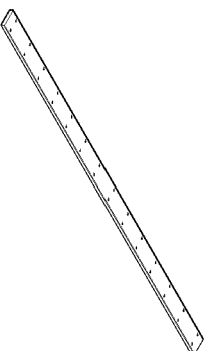

X4

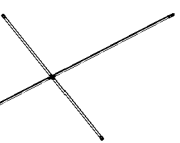

X1

1

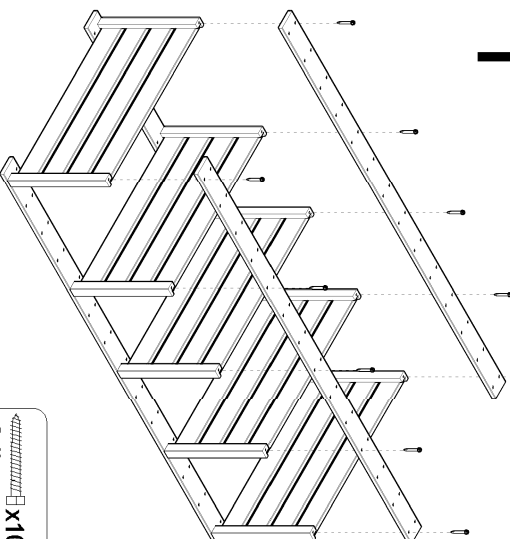

2

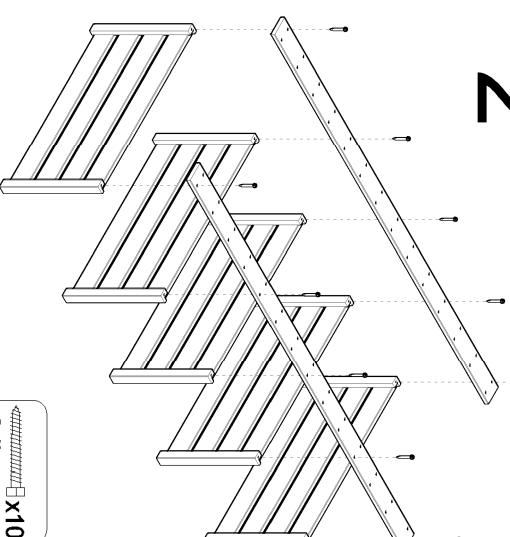

3

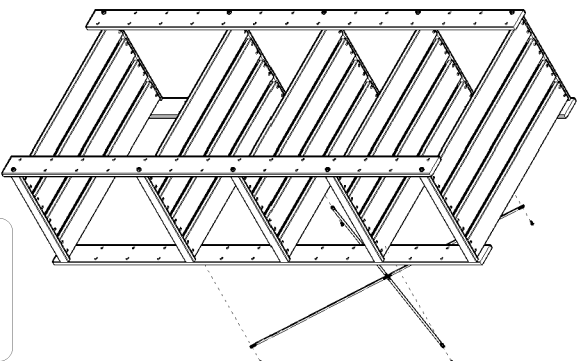

X4 3 x 15 mm

4

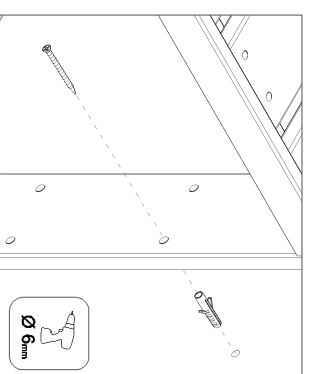

X10 5 x 60 mm

X10 5 x 60 mm

X2 4,5 x 50 mm

X2 6 x 30 mm

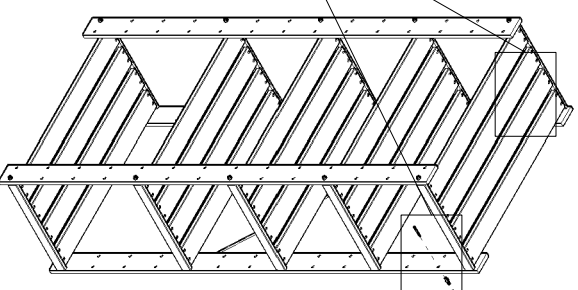

ref. EVM457.99

ASTIGARRAGA

ast line

Oldies Area nº3
E-20730 Azpeitia (GI)
T. +34 945 814 261 F. +34 945 816 713
astigarraga@astline.es
www.astline.es

