

# MONTAJE / MONTAGE / MONTAGGIO / MONTAGEM / ASSEMBLY / BEDIENUNGSANLEITUNG

## FR NOUS VOUS CONSEILLONS

- Poser les colis en position horizontale
- Classer et compter les éléments de montage et la quincaillerie
- Définir une zone de montage
- Suivre dans l'ordre les instructions de montage

## ES TE ACONSEJAMOS

- Poner el paquete en posición horizontal
- Ordenar y contar las piezas y herrajes
- Habilita una zona para el montaje
- Sigue paso a paso las instrucciones de montaje

## IT VI INFORMIAMO

- Porre la confezione in orizzontale
- Mettere in ordine e contare le minuterie metaliche
- Essere certi di avere spazio a per il montaggio
- Seguire passo passo le istruzioni

## DE WIR RATEN IHNEN

- Legen Sie das Paket in eine horizontale Position, bevor Sie es öffnen
- Ordnen und zählen Sie die Teile und Beschläge
- Richten Sie einen Platz für die Montage ein
- Folgen Sie die Montageanleitung Schritt für Schritt

## EN I ADVISE YOU

- Put the package in horizontal position
- Put in the order and count the pieces and iron fittings
- Take enough space for assembly
- Follow step by step the assembly instruction

## FR Outils de montage nécessaires (not inclus dans le kit)

## ES Las herramientas que necesitas (no incluidas en el kit)

## IT Gli attrezzi che vi servono per il montaggio (non inclusi nella confezione)

## DE Erforderliches Werkzeug (nicht im Bausatz enthalten)

## EN The tools that you need for assembly (not included in the package)



## FR Quincaillerie incluse dans le kit

## ES Los herrajes que encontrarás en el kit

## IT Accessori inclusi nella confezione

## DE Die Beschläge, die Sie im Bausatz finden

## EN The tools that you will find in the package



x 1

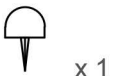

x 1

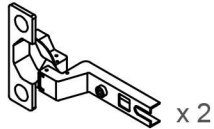

x 2

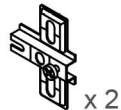

x 2

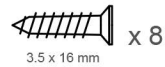

x 8

3.5 x 16 mm



x 1

4.5 x 35 mm

## FR Pièces incluses dans le kit

## ES Las piezas incluidas en el kit

## IT Parti incluse nella confezione

## DE Die im Bausatz enthalten Teile

## EN The pieces included in the package

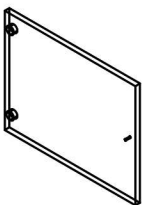

x 1

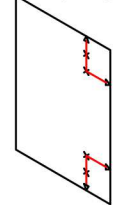

x 1

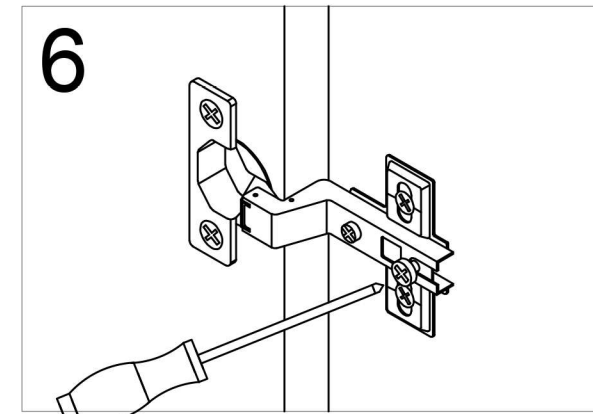
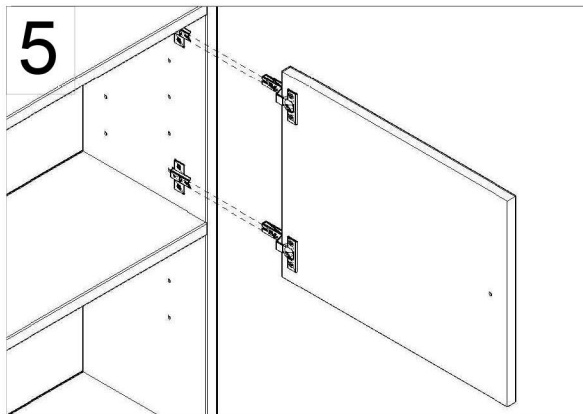
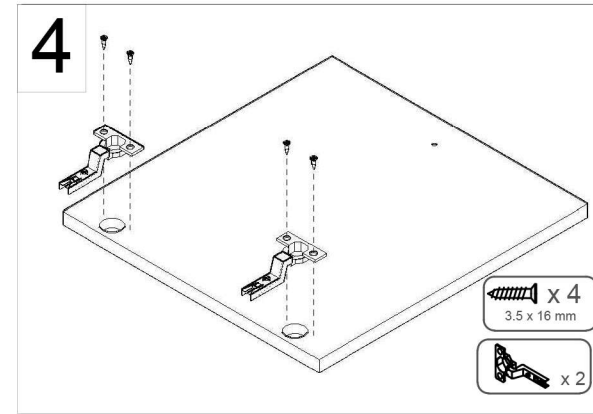
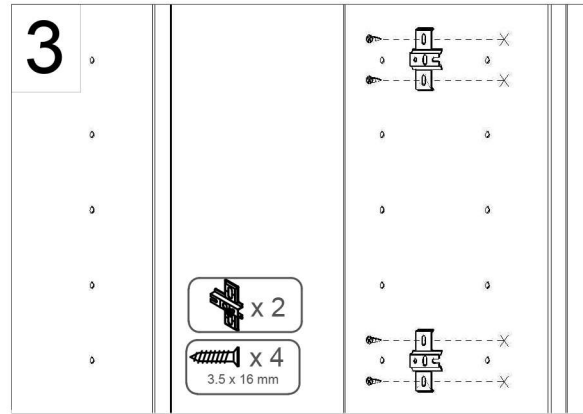
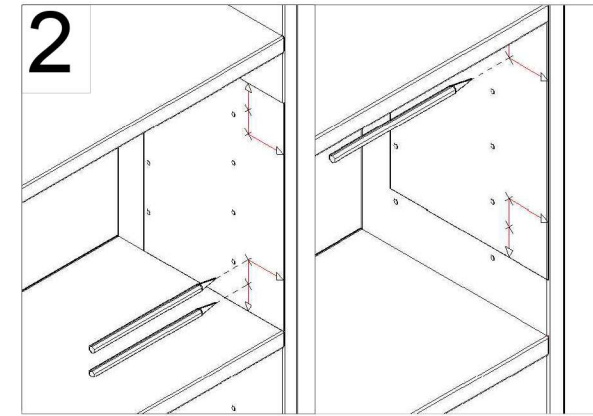
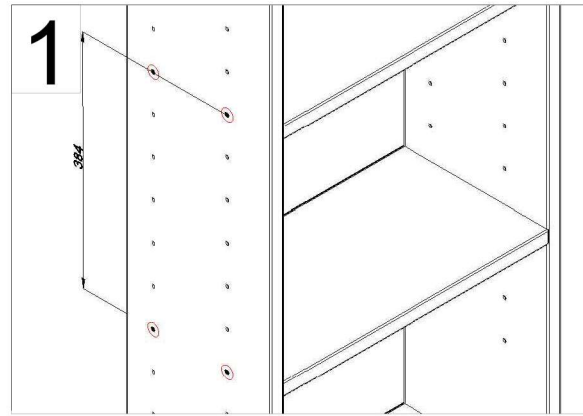

ref. GAPT50.99



FR Pensez à donner ou recycler.



Associazioni



Magasin



Recycling

https://www.procommodschets.jp



PEFC/14-38-00151

**ASTIGARRAGA**  
kit line



Olalde Area N°3  
20730 Azpeitia (Gipuzkoa)  
Tel. +34 943 814 261 - Fax +34 943 816 713  
info@astikitline.es  
www.astikitline.com



